

Diagnostizarea cablurilor de inalta tensiune



GA Magyarország

Törökbálint, 24 februarie 2011

GA Magyarország Kft.





1. Strategia de mentenanta utilizata la retelele de cabluri
2. Consideratii generale privind izolatia cablurilor de inalta tensiune
3. Caracteristicile retelelor de cabluri de inalta tensiune, imbatrinirea (scaderea calitatii) izolatiei,
4. OWTS[®] HV 150 date tehnice, constructie, mod de functionare



5. Masuratori si prelucrarea / analiza datelor
6. Standarde si recomandari
7. Concluzii - Rezumat

Strategia de mentenanta
utilizata la cabluri de inalta tensiune



Diagnostizarea cablurilor de inalta tensiune

Strategia de mentenanta utilizata la cabluri



1. Interventie la defectiune
2. Interventie programata functie de timp
3. Mentenanta functie de timp
4. Mentenanta bazata pe functionare sigura a retelei

1. Interventie la defectiune



— Interventie la defectiune

t_1 : durata de viață

K_0 : costul mentenantei (reparatiei)

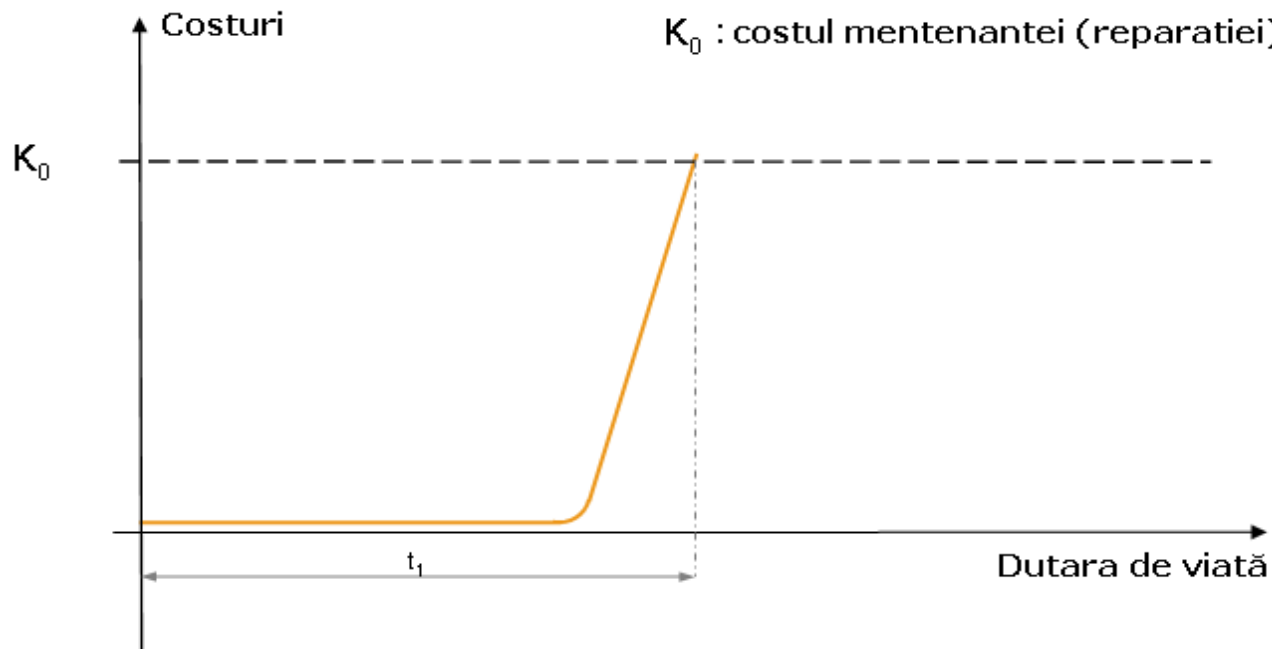

Avantaje

Cheltuielile de intretinere sunt ne semnificative

Nu necesita diagnosticare

Dezavantaje

Nealimentarea consumatorilor pe durata inlaturarii defectului.
Pierdere neprevazuta de venituri (din vinzarea energiei electrice).

Informatii minime referitoare la starea cablului.
Creste deranjamentul neprevazut al consumatorilor.

Nu se poate asigura calitatea contractata a alimentarii cu energie electrica a consumatorilor.

2. Interventie programata functie de timp



— interventie la defectiune
— interventie programata

t_1-t_2 : durata de viață a cablului

K_0 : costurile de mentenanta

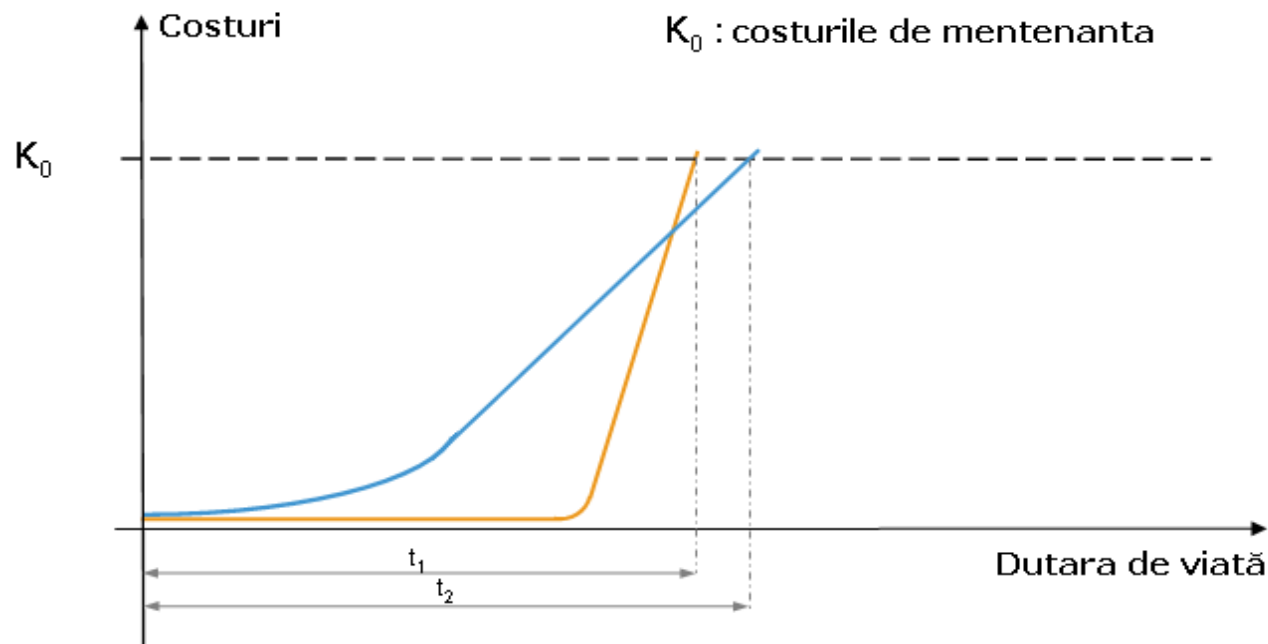

Avantaje

Intretinerea se poate programa in timp

Nu necesita diagnostizare

Cheltuielile de intretinere sunt minime

Dezavantaje

Riscul schimbarii inainte de termen a cablului

Nu se cunoaste starea actuala a cablului

Informatii minime referitoare la imbatrinirea cablului

Decizii gresite de investitii din cauza lipsei de informatii referitoare la starea cablului

3. Mentenanta functie de timp

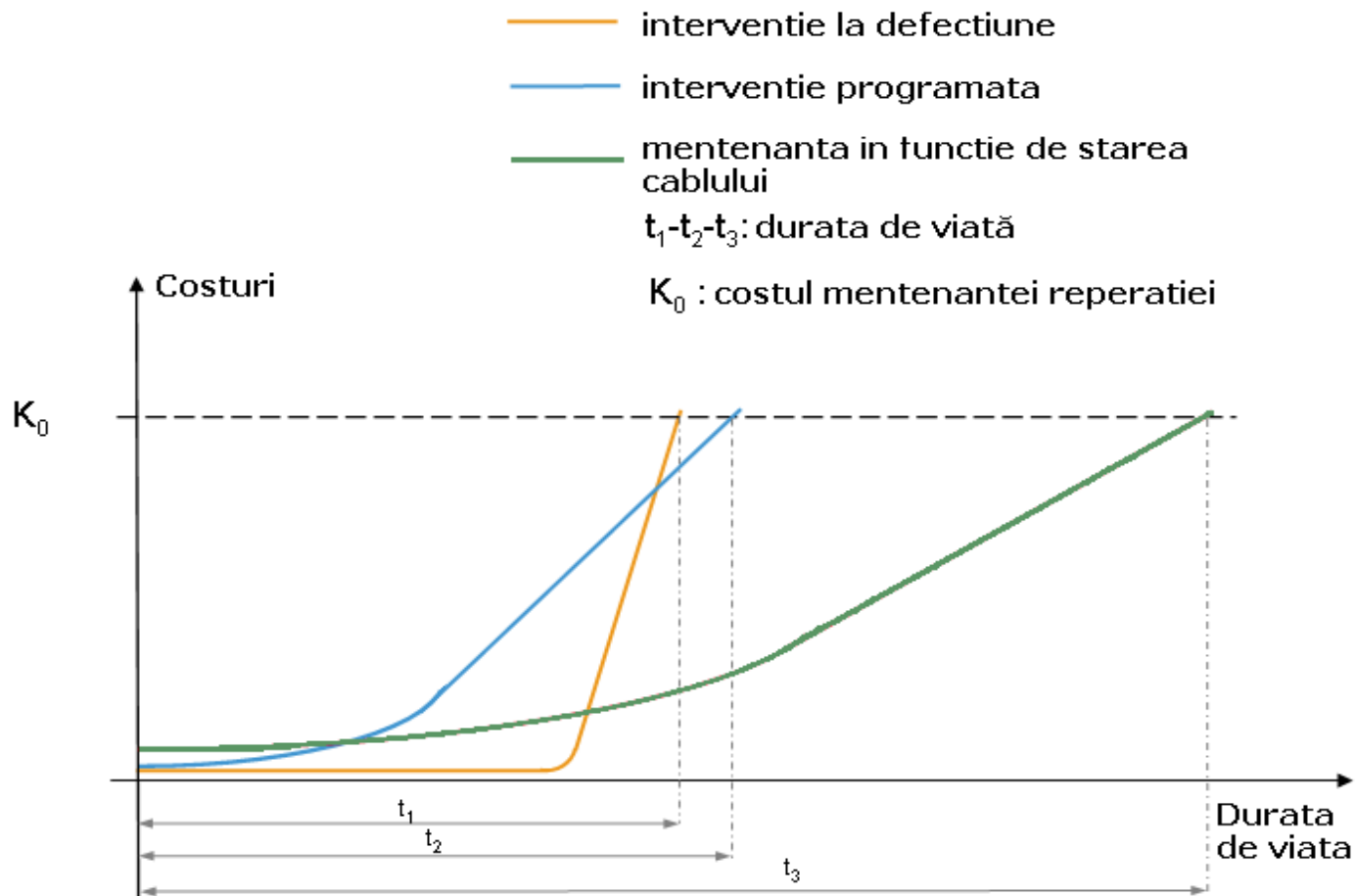

Avantaje

Mentenanta si reparatia capitala se face pe baza de date concrete

Programarea interventiei pe baza de date concrete Interventie precisa in baza diagnosticarii.

Prelungirea duratei de viata a instalatiei, costuri mai mici de intretinere

Dezavantaje

Urmarirea continua a datelor care influenteaza reparatiile si programarea interventiilor

4. Mentenanta bazata pe functionare sigura a retelei

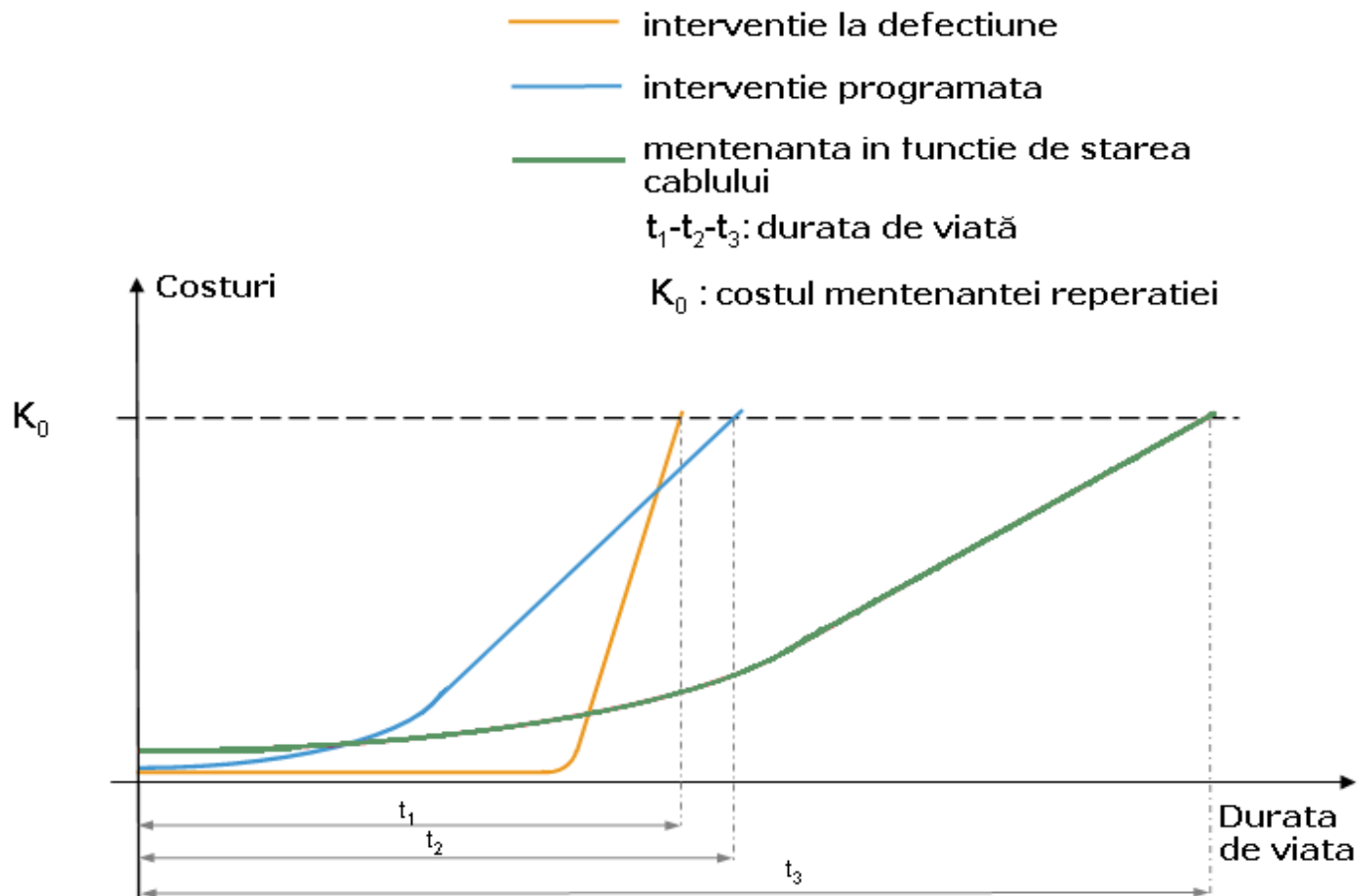

Avantaje

Mentenanta si reparatia capitala se face pe baza de date concrete

Programarea interventiei pe baza de date concrete.
Interventie precisa in baza diagnosticarii.

Prelungirea duratei de viata a instalatiei, costuri mai mici de intretinere

Micsorarea pauzelor de tensiune neprevazute

Posibilitatea indeplinirii conditiilor contractuale asumate

Dezavantaje

Urmarirea continua a datelor care influenteaza reparatiile si programarea interventiilor

Analiza defectului din punct de vedere tehnic si economic

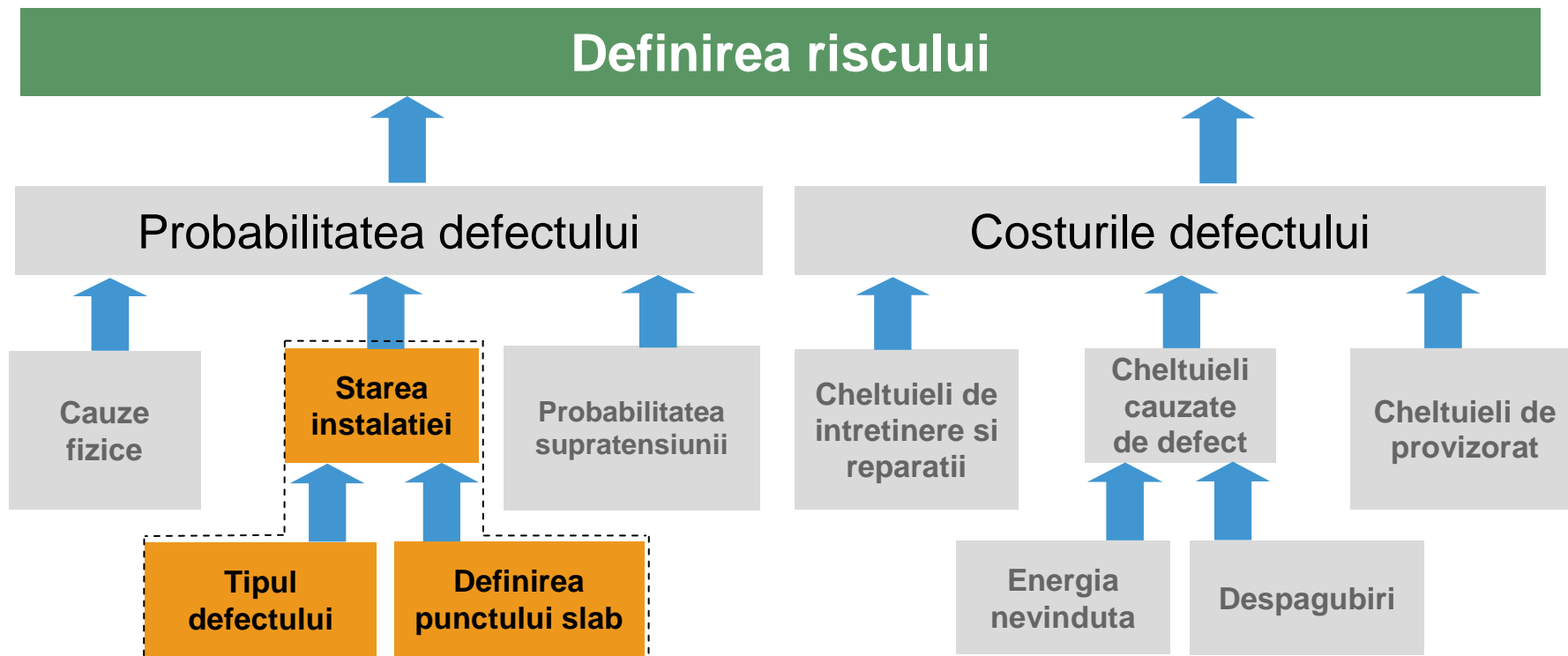

Aspectele generale ale izolatiei cablurilor

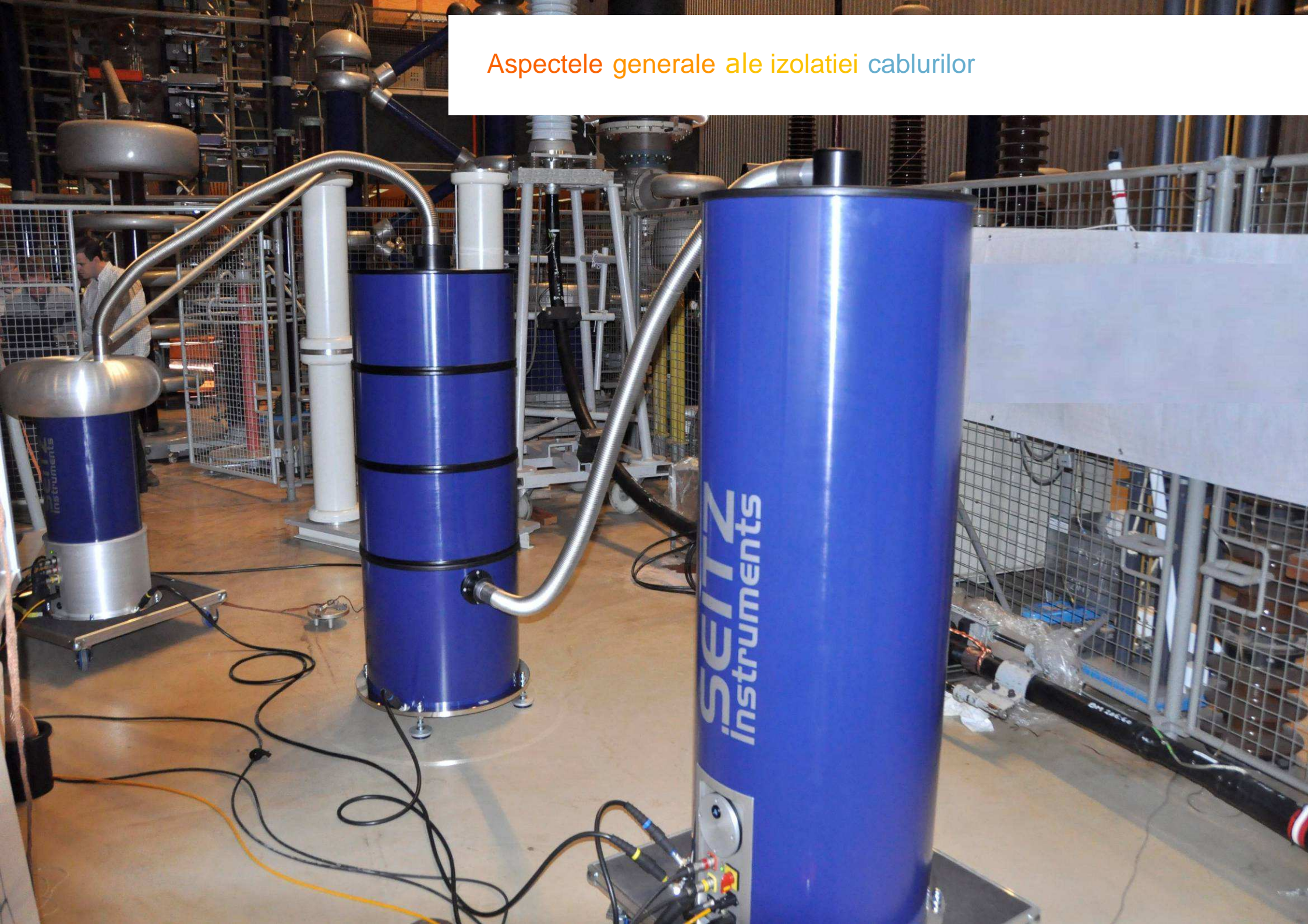

Aspectele generale ale incercarilor de cabluri inainte de P.i.f.



Parametri de calitate, defctiuni cauzate de transport si montare

1. Parte integranta a executiei, verificarea parametrilor cablurilor (pe baza certificatelor de calitate) verificarea elementelor componente ale retelei (atestind calitatea partilor componente ala retelei)
2. Verificarea completa a retelei executate, inainte de P.i.f. (mansoane, capuri terminale), pentru descoperirea eventualelor probleme / defecte de executie, care ulterior pot cauza avarii

Aspecte generale ale diagnosticării rețelelor de cablurilor în funcțiune



Rolul diagnosticării în siguranța și fiabilitatea rețelelor de cabluri

1. Cerințele primare impuse față de diagnosticare:
 - date generale despre starea calității izolației rețelei studiate
 - estimarea fiabilității elementelor rețelei (capuri terminale, mansoane)
 - suport pentru diagrama de reparație programată / mentenanță
2. Cerința secundară a diagnosticării este obținerea unei „amprente” a rețelei de cablu fiind baza la măsurătorile ulterioare, din care rezultă clar:
 - modul de îmbătrânire a rețelei,
 - punctele slabe ale rețelei (capuri terminale, mansoane),
 - descărcările parțiale, din care se pot stabili punctele unde se vor produce



Caracteristicile retelelor de cabluri de inalta tensiune, imbatrinirea izolatiei

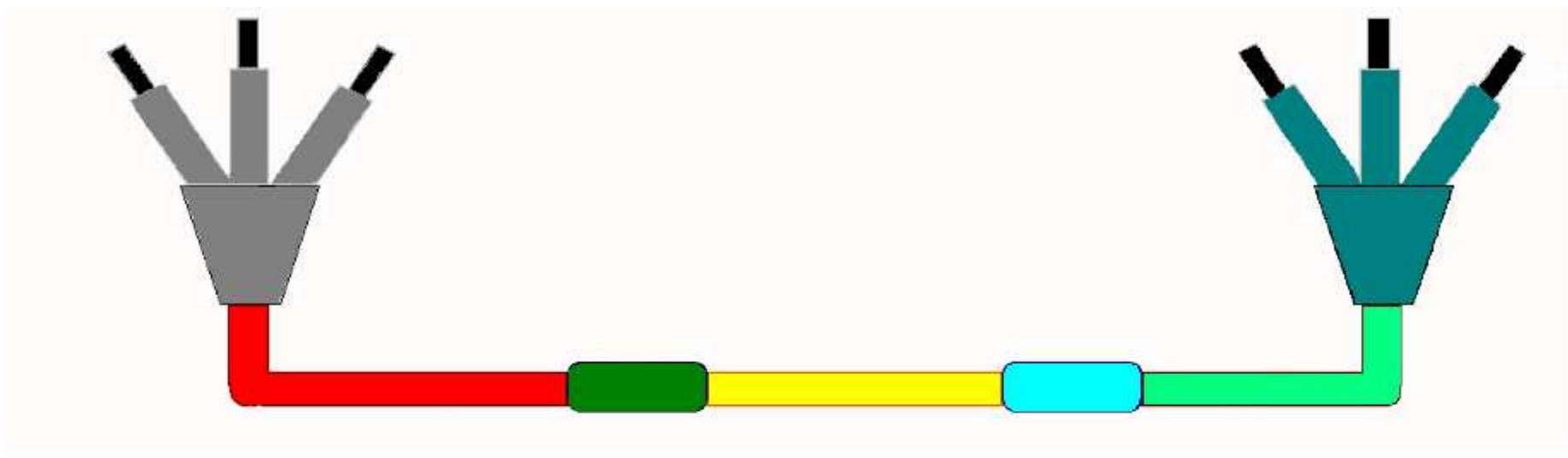

Elementele componente ale retelei:

- cablu propriuzis
- mansoane
- capuri terminale

Caracteristicile componentilor:

- tipuri diferite
- durata de viata diferita
- antecedente diferite

Imbatrinirea izolatiei la cablurile cu izolatie extrudata

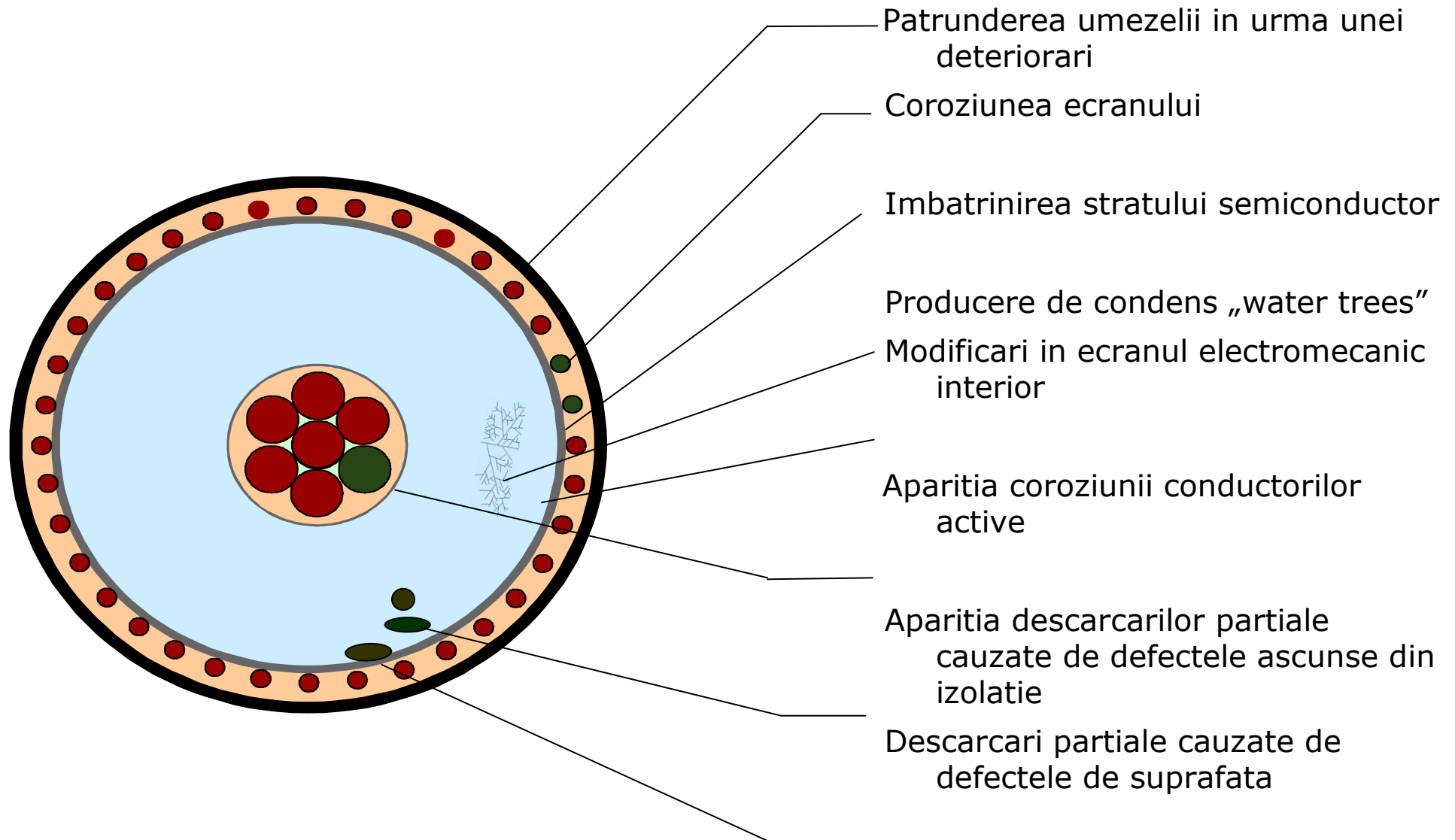



1. Defectunile cablurilor de putere, in marea majoritate a cazurilor sunt cauzate de probleme de izolare

2. Natura problemelor de izolare :

- la cabluri noi: montari defectuoase la mansoane si capuri terminale, mai rar defecte ascunse in izolatia cablurilor
- la cabluri in functiune: imbatrinirea izolatiei cablurilor si in mai mica masura a capurilor terminale si a mansoanelor



Degradatia izolatiei functie de aparitie poate fi:

- Locala, cauzata de un defect ascuns
- Generala, datorata imbatrinirii in timp

Natura degradatiei izolatiei poate fi:

- Neomogena, caracterizata prin aparitia descarcarilor partiale
- Omogena, caracterizata prin micșorarea performantelor dielectricului

OWTS® HV 150 modul de functionare,
constructie, date tehnice



OWTS constructie si modul de functionare (faza de incarcare a cablului - energetizare)

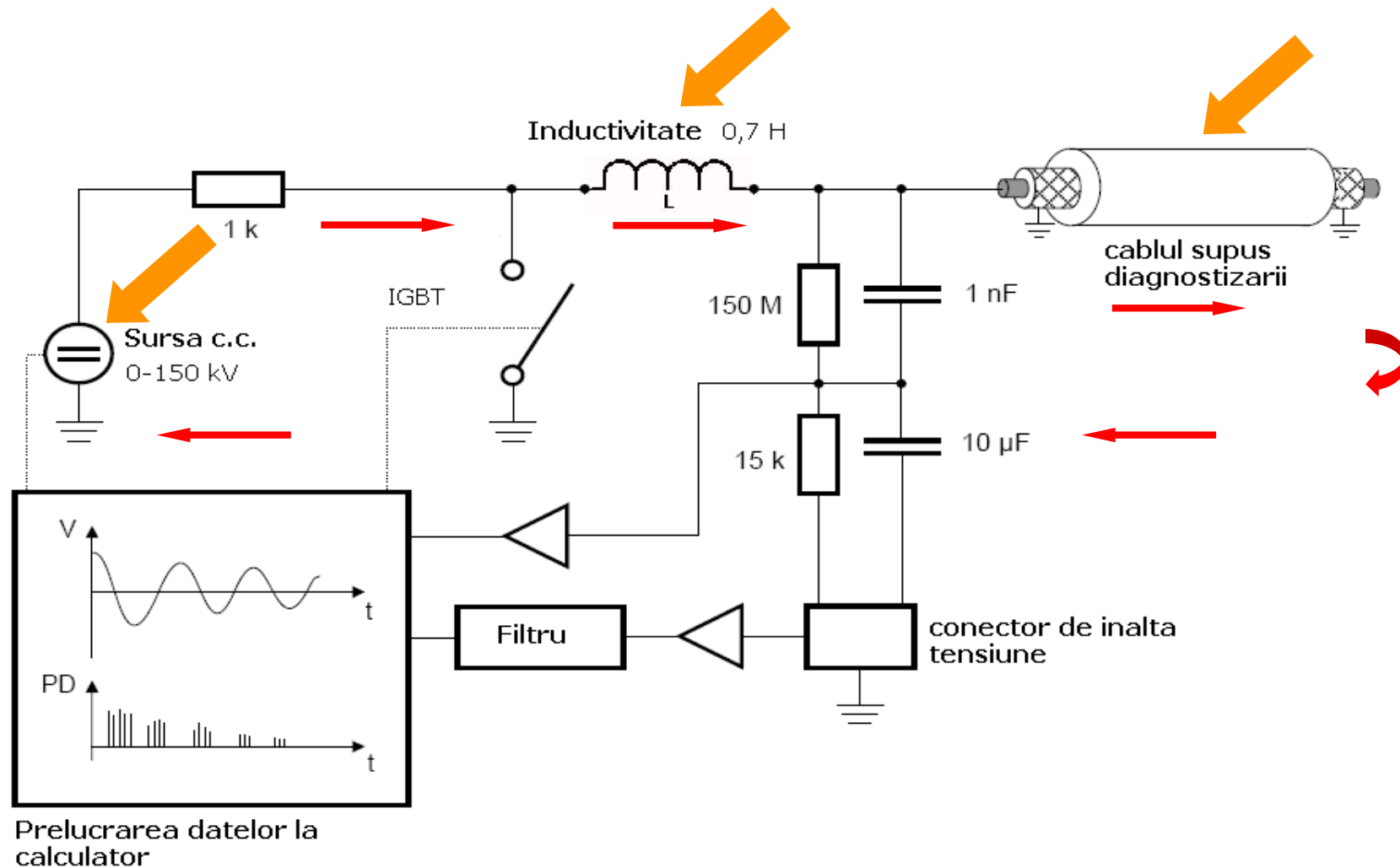

OWTS constructie si modul de functionare (faza de descarcare – masurarea parametrilor)

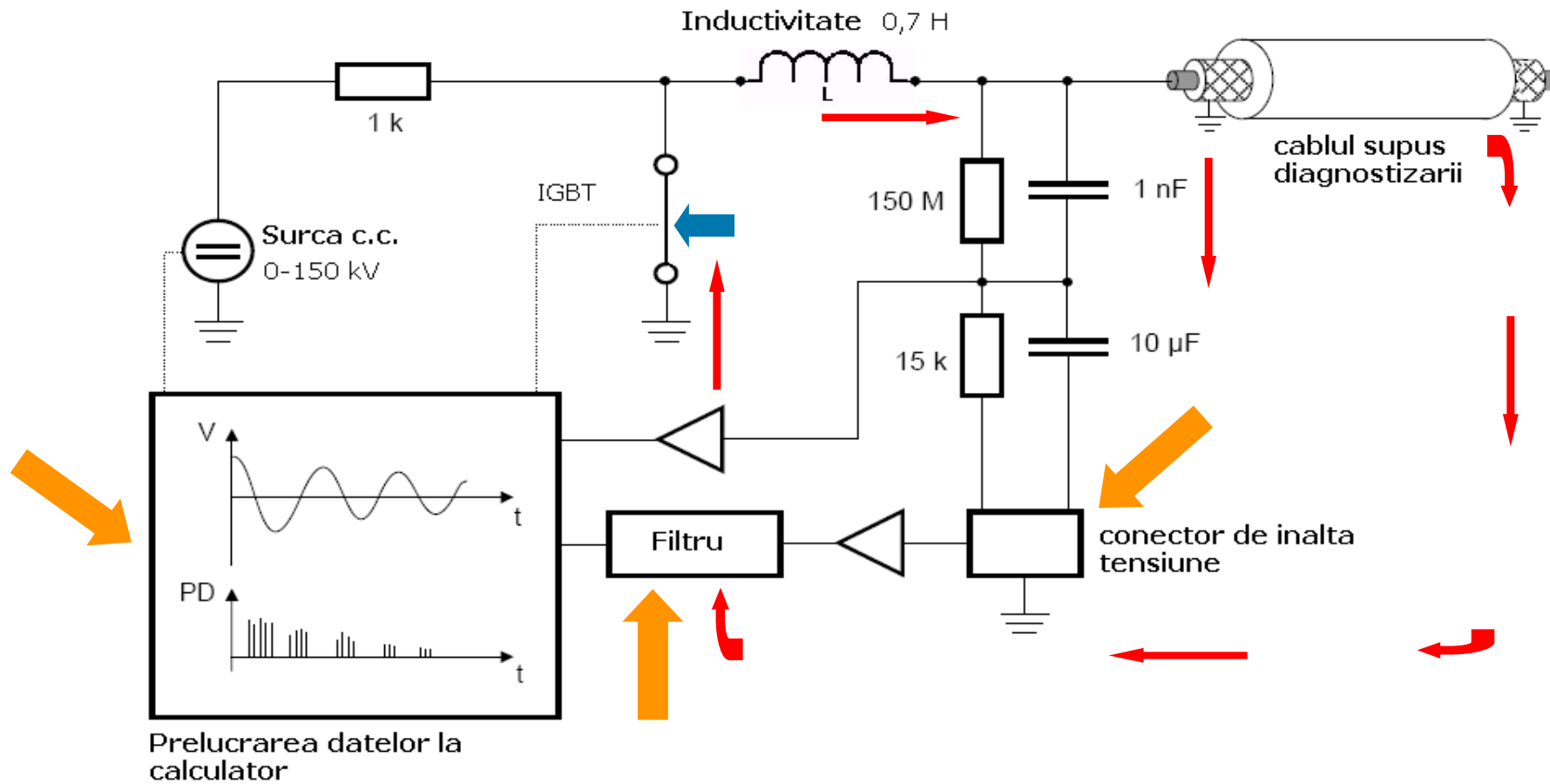

OWTS® HV 150 datele tehnice ale instalatiei

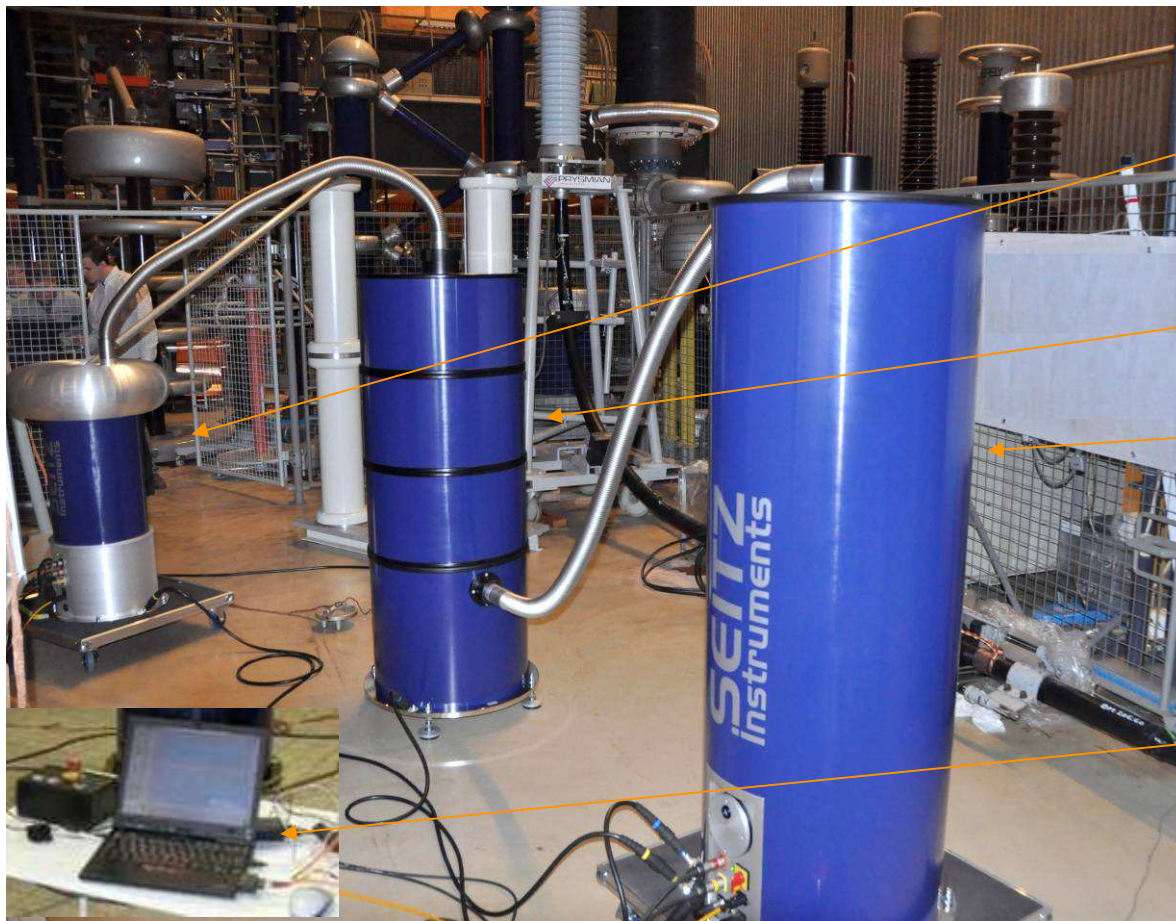

Conector de inalta tensiune

Inductivitate

Intrerupator IGBT
Sursa de c.c.

Prelucrarea datelor
la calculator

OWTS® HV 150 datele tehnice ale instalatiei



- Greutatea totala:
- 780 kg
- Lungimea cablurilor ce poate fi masurata: 100 m - 20 km
- Timpul de asamblare si demontare:
- cca. 2 ore fiecare
- Timpul de calibrare a instalatiei:
- 0,5 ore
- Masurarea descarca-rilor partiale pe teren: 0,5 ore/faza



1. Tensiunea alternativa maxima (DAC): $150 \text{ kV}_{\text{virf}}/106 \text{ kV}_{\text{ef}}$
2. Zona de frecventa a tensiunii alternative: $15 \text{ Hz} - 600 \text{ Hz}$
3. Capacitatea maxuma a cablului masurat: $0,025 \mu\text{F} - 8 \mu\text{F}$
4. Curentul de incarcare: 10 mA
5. Intervalul masurabil al descarcarilor partiale: $1 \text{ pC} - 100 \text{ nC}$
6. Masurarea descarcarilor partiale: conf. IEC 60270
7. Zona de masurare: $150 \text{ kHz} - 20 \text{ MHz}$
8. Valoarea $\text{tg}\delta$: $0,1\% - 5\%$
9. Intervalul temperaturii ambiante: $-10^\circ\text{C} - +50^\circ\text{C}$

Masuratori in teren si prelucrarea datelor



Masuratori in teren si analiza datelor

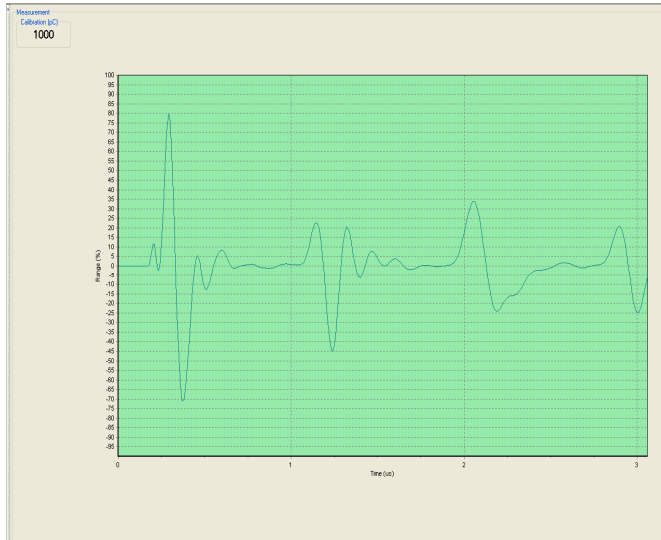

- Calibrarea (1000 pC):
- Amplitudinii conf. IEC 60270
 - Lungimii conf. TDR

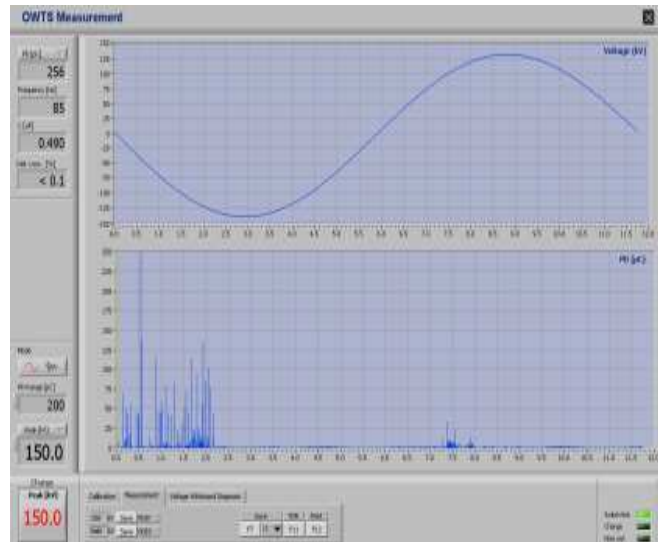

- Tensiunea oscilanta amortizanta;
- Vizualizarea descarcarii partiale

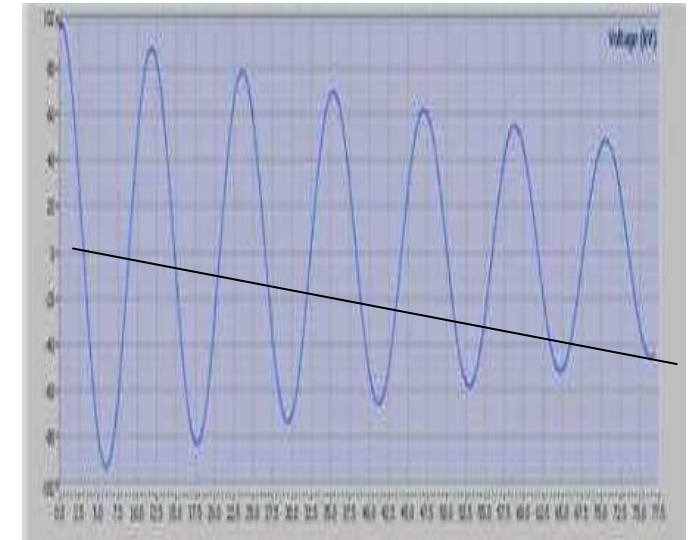

- Vizualizarea - masurarea pierderilor dielectrice pe baza undelor oscilatorii

Masuratori in teren si analiza datelor

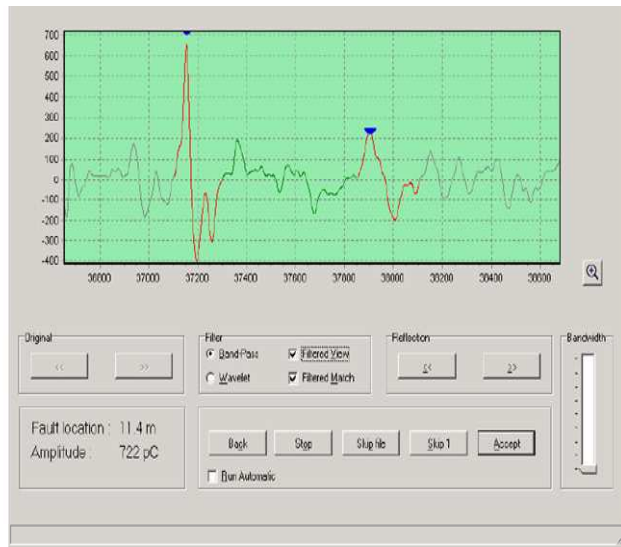

Analiza descarcarilor
partiale pe baza undelor
prodate

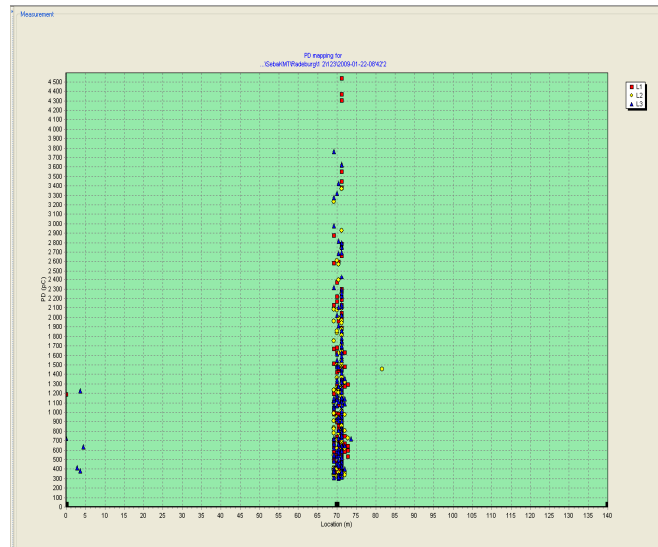

Harta descarcarilor
partiale I,
Vizualizarea punctelor de
producere a descarcarilor

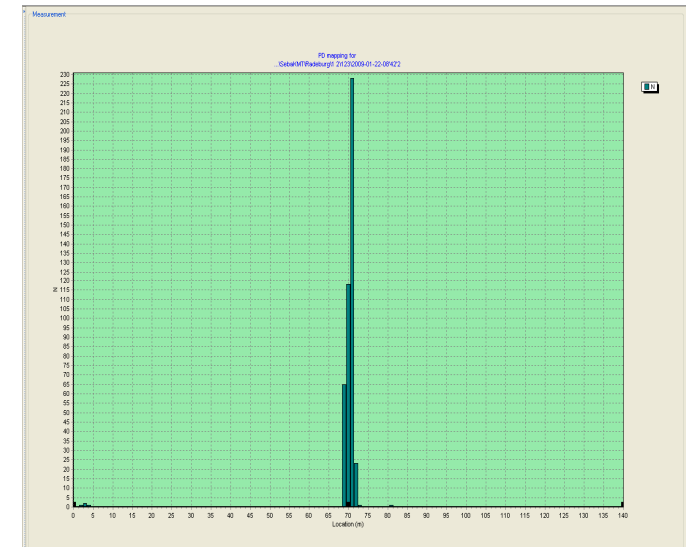

Harta descarcarilor
partiale II,
Vizualizarea numarului
descarcarilor partiale

Vizualizarea punctelor slabe la un cablu cu izolatie de polietilena (XLPE), dupa pozare

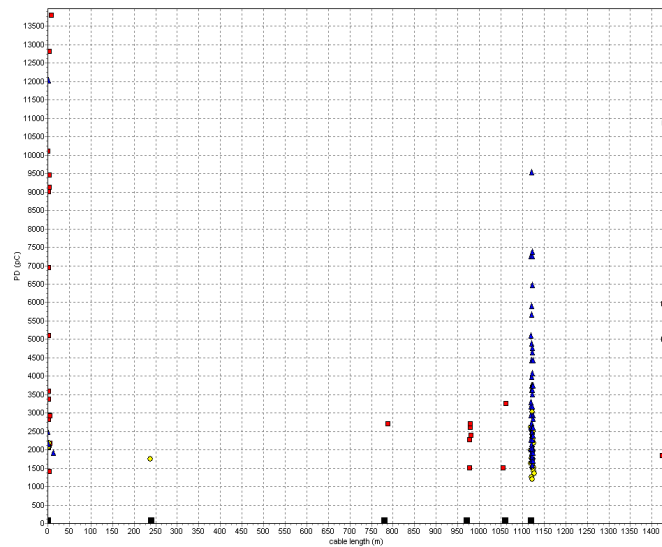

In loc de un raspuns „DA / NU”
referitor la starea
cablului,

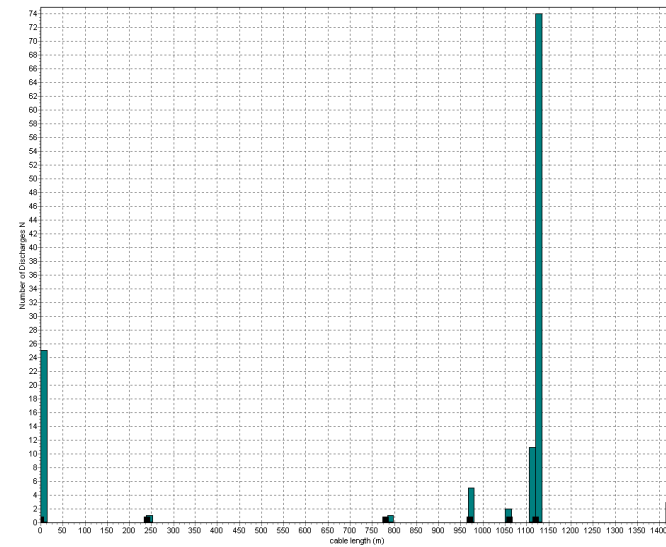

... informatii concrete –
puncte concrete, privind
punctele slabe ale
cablului

Vizualizarea punctelor slabe la un cablu cu izolatie de hirtie (PILC), in functiune

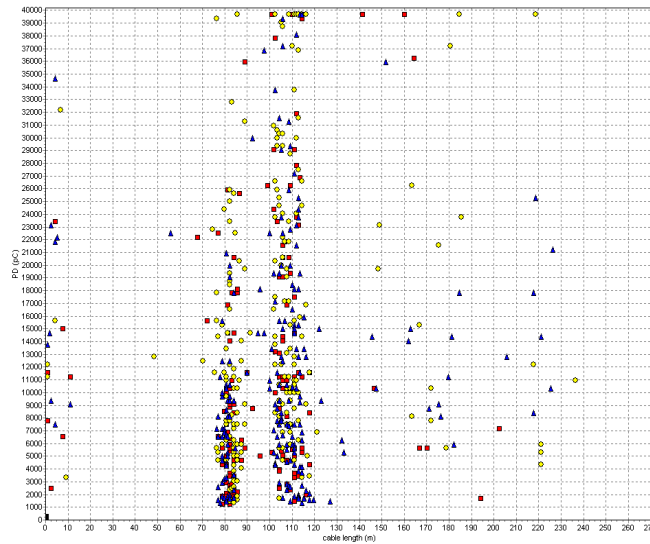

„Punc slab local”

Descarcari partiale concentrate – prelungirea vietii cablului este posibila prin remediere

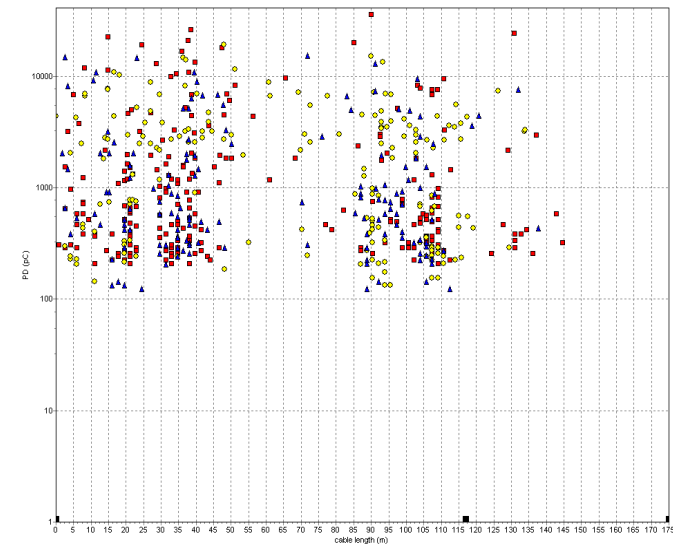

„Puncte slabe extinse”

Descarcari partiale pe tronsoane, imbatrinire avansata a izolatiei – schimbarea este oportuna

Masuratori inainte si dupa reparatia cablului cu izolatie de hirtie (PILC), in functiune



Inainte de reparatie

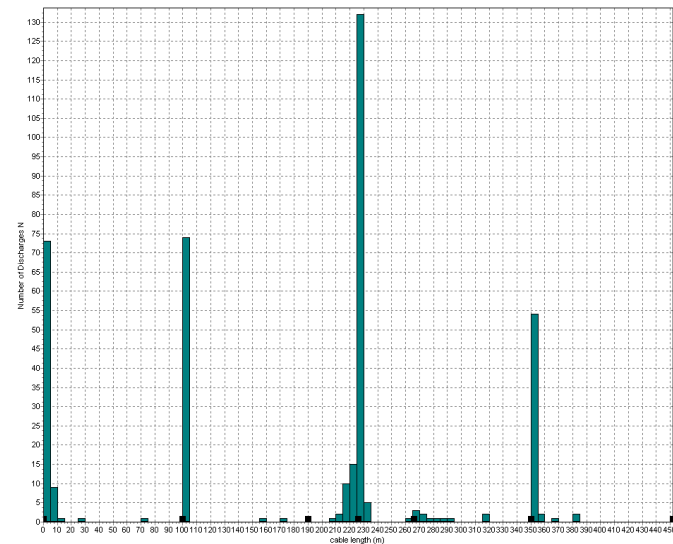
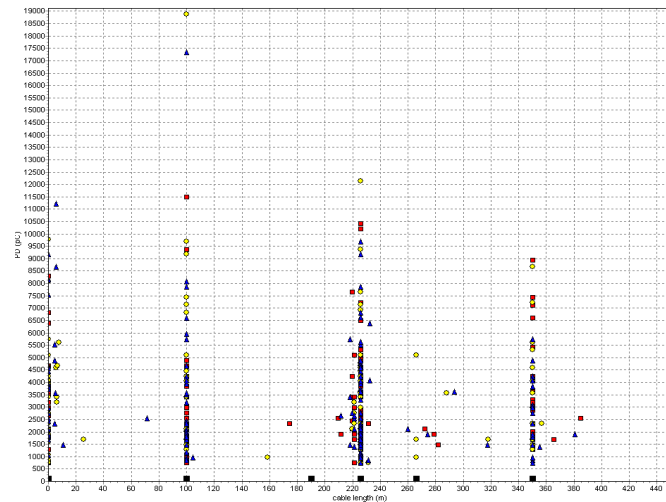

Dupa reparatie

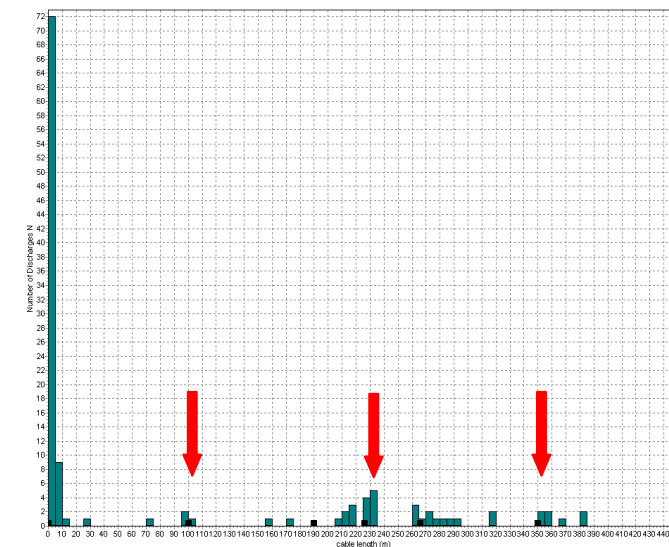
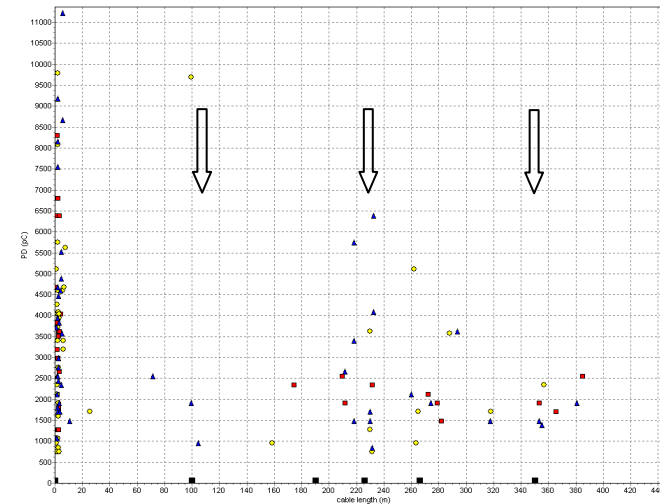



Standarde, recomandari



- **IEC 60270:** Masurarea descarcarilor partiale
- **IEC 885-3:** Metode de masurare a descarcarilor partiale la cablurile de forta cu izolatia de polietilena
- **IEEE 400.3:** Ordin privind masurarea descarcarilor partiale la cablurile ecranate, pozate in zona statiilor de transformare
- **IEC 60840:** Metode de analiza si cerinte la cablurile cu izolatia de polietilena si armaturi pentru tensiunile cuprinse intre 30 kV ($U_m = 36$ kV) si 150 kV ($U_m = 170$ kV)
- **IEC 60060-3:** Tehnica masuratorilor la inalta tensiune – cap. 3. – Definirea si cerintele inspectiei locale

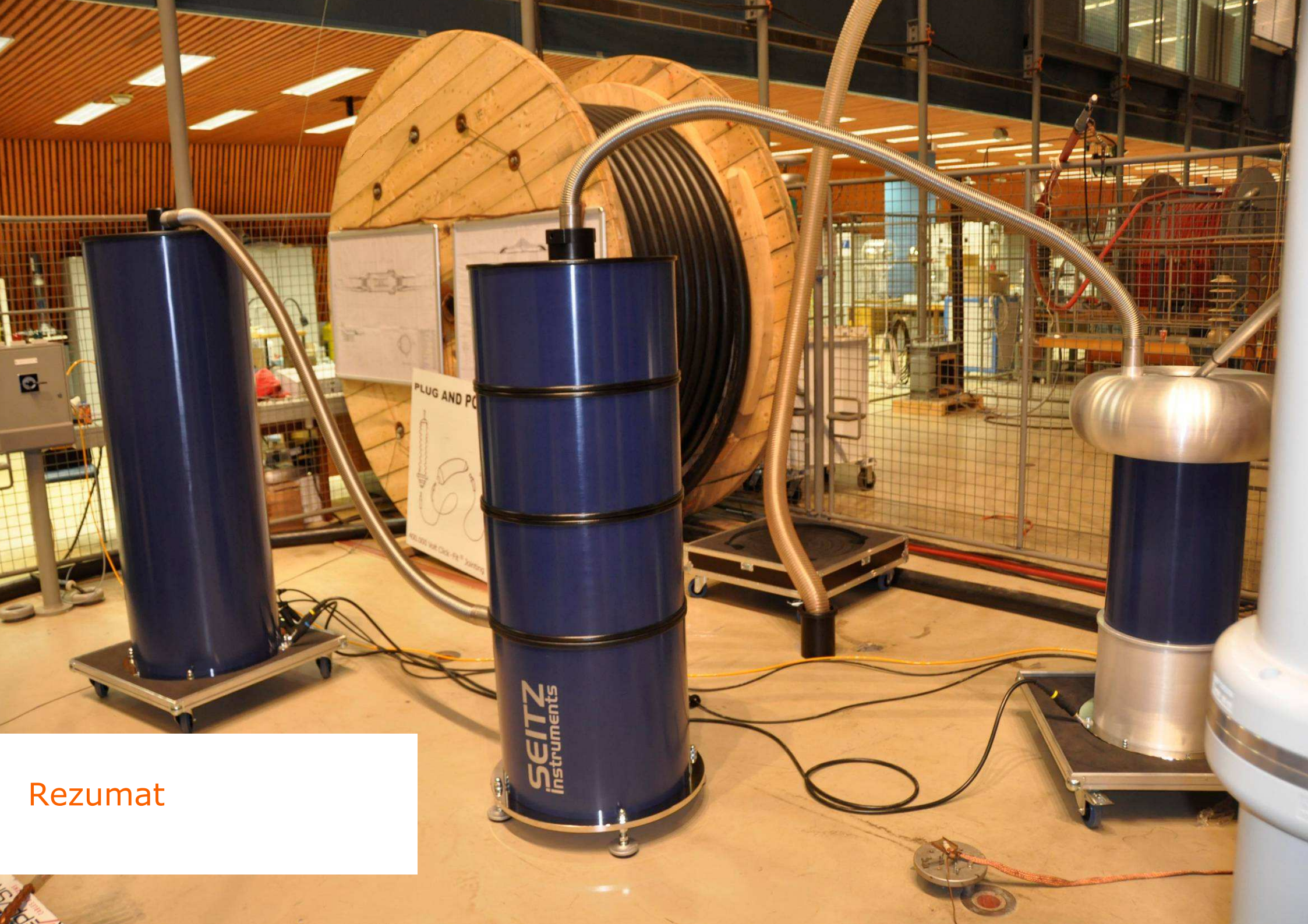

Rezummat



- Mentenanta in vederea cresterii fiabilitatii si a duratei de viata a retelei
- Extinderea ciclului de reconstructie, in vederea scaderii cheltuielilor de investitie
- Informatii sigure referitoare la starea retelei – posibilitatea interventiei la punctele slabe
- Posibilitatea analizei retelei inainte de P.i.f., pentru a preveni aparitia defectelor ulterioare
- In locul raspunsului simplu „DA/NU” referitor la calitatea licrarii, posibilitatea analizei partilor componente ale retelei
- Posibilitatea analizei retelei intr-un spectru larg din punct de vedere al informatiilor referitoare la calitate
- Posibilitatea urmaririi inbatrinirii (scaderea calitatii) izolatiei prin repetarea ciclica a masuratorilor

Contacte



GA Magyarország

Fábián Mátyás, sef bransa cabluri IT

Telefon +36 20 9225 204

e-mail: fabian.matyas@ga.hu

Bauer Gábor, sef de proiect

Telefon +36 20 9701 280

E-mail: bauer.gabor@ga.hu

Egyed Róbert, sef masuratori

Telefon +36 20 283 6405

e-mail: egyed.robert@ga.hu